

V2H Bundle

A reference guide for owners of:

- The GM Energy PowerShift Charger (to charge your GM EV)
- The GM Energy V2H Enablement Kit (to redirect power from your Compatible GM EV to your Home)

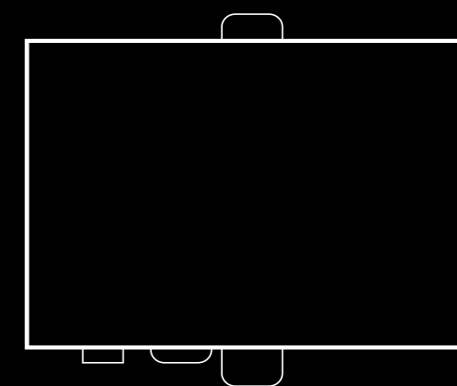
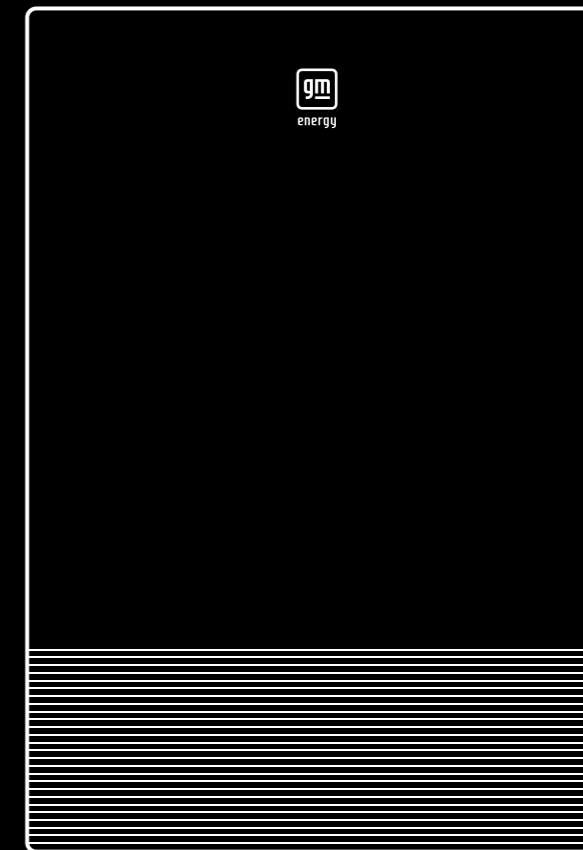
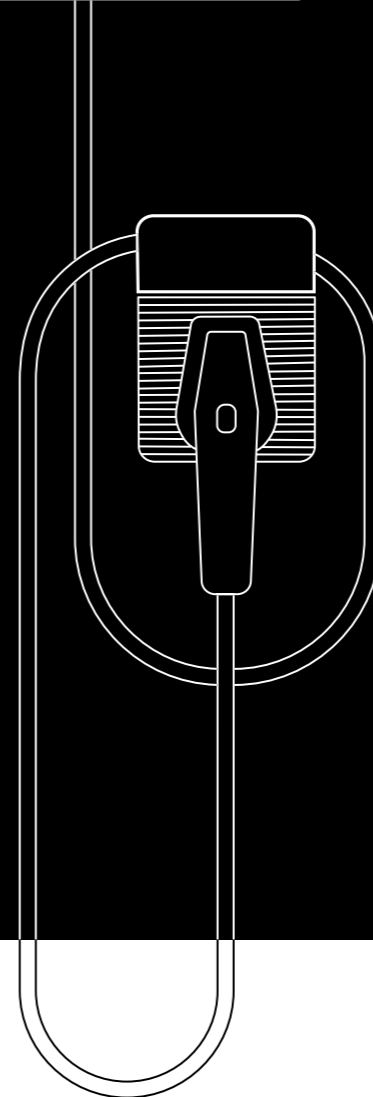
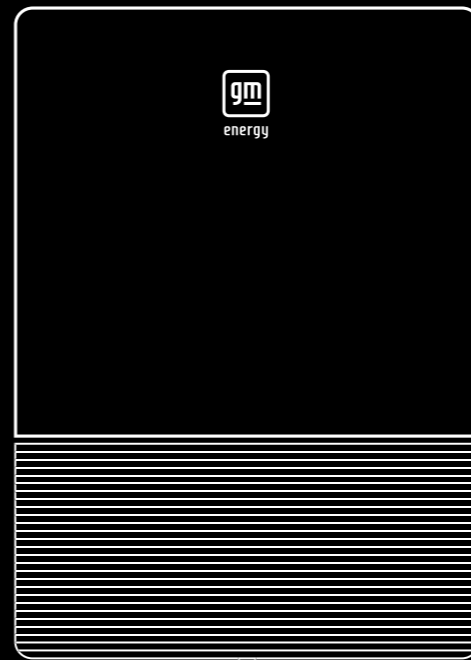
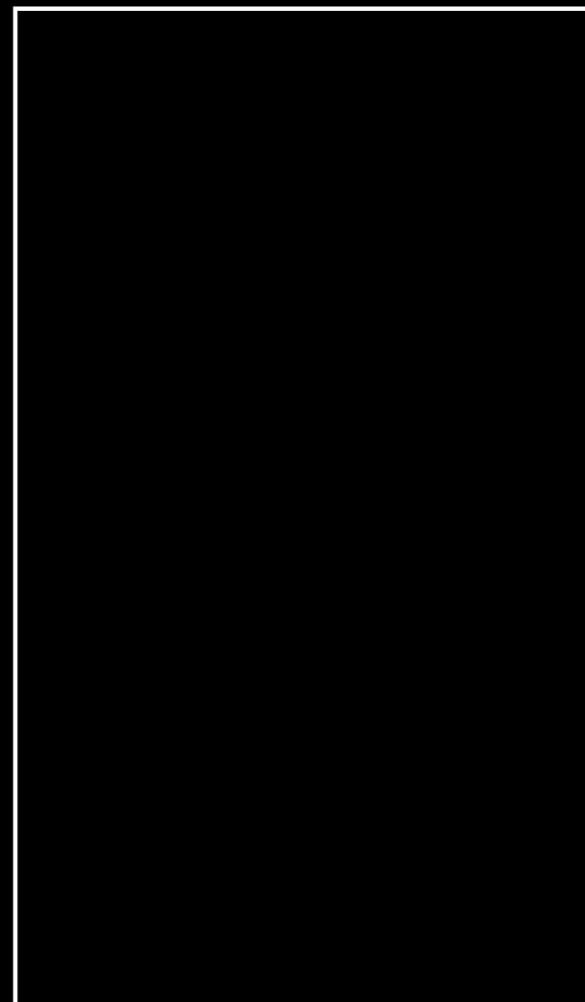

User Manual

Version 1-2 - January 2025

TABLE OF CONTENTS

Welcome 3

Congratulations on Choosing the GM Energy V2H Bundle

Important Safety Instructions 4

Save These Instructions

Federal Communications Commission Interference Statement

Getting To Know Your System 5

Each Component Has a Job

GM Energy PowerShift Charger

GM Energy Home Hub

GM Energy Inverter

GM Energy Dark Start Battery

Need-To-Know Action Items..... 10

Charging Your GM EV

Troubleshooting Tips

Decoding the Blinking LED Lights

Using Your GM EV’s Mobile App.....17

First-Time Setup

Enabling Automatic Backup Power

Why You Need the App

Over-the-Air Updates (OTA)..... 18

Care And Maintenance 19

Helpful Resources

GM Energy Home Products Limited Warranty20

Glossary..... 21

Frequently Used Terms and Acronyms

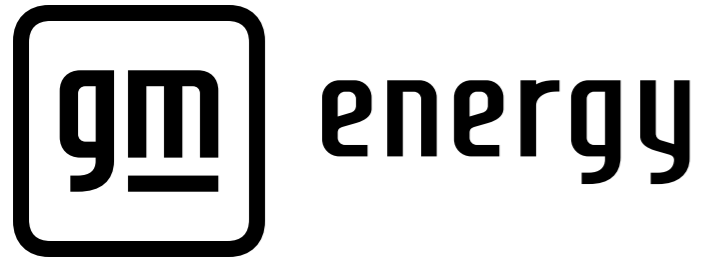

WELCOME

Congratulations on Choosing the GM Energy V2H Bundle

This guide is designed to familiarize you with the GM Energy **Vehicle-to-Home (V2H)** Bundle. You will find a component overview, how-to tips, troubleshooting information and more. In the back of this User Manual, you'll find a **Glossary** of terms frequently used here and in other GM Energy resources.

How to use this interactive PDF

Use the **Arrow Buttons** to navigate between pages, or use the **Home Button** to return to the **Table of Contents**.

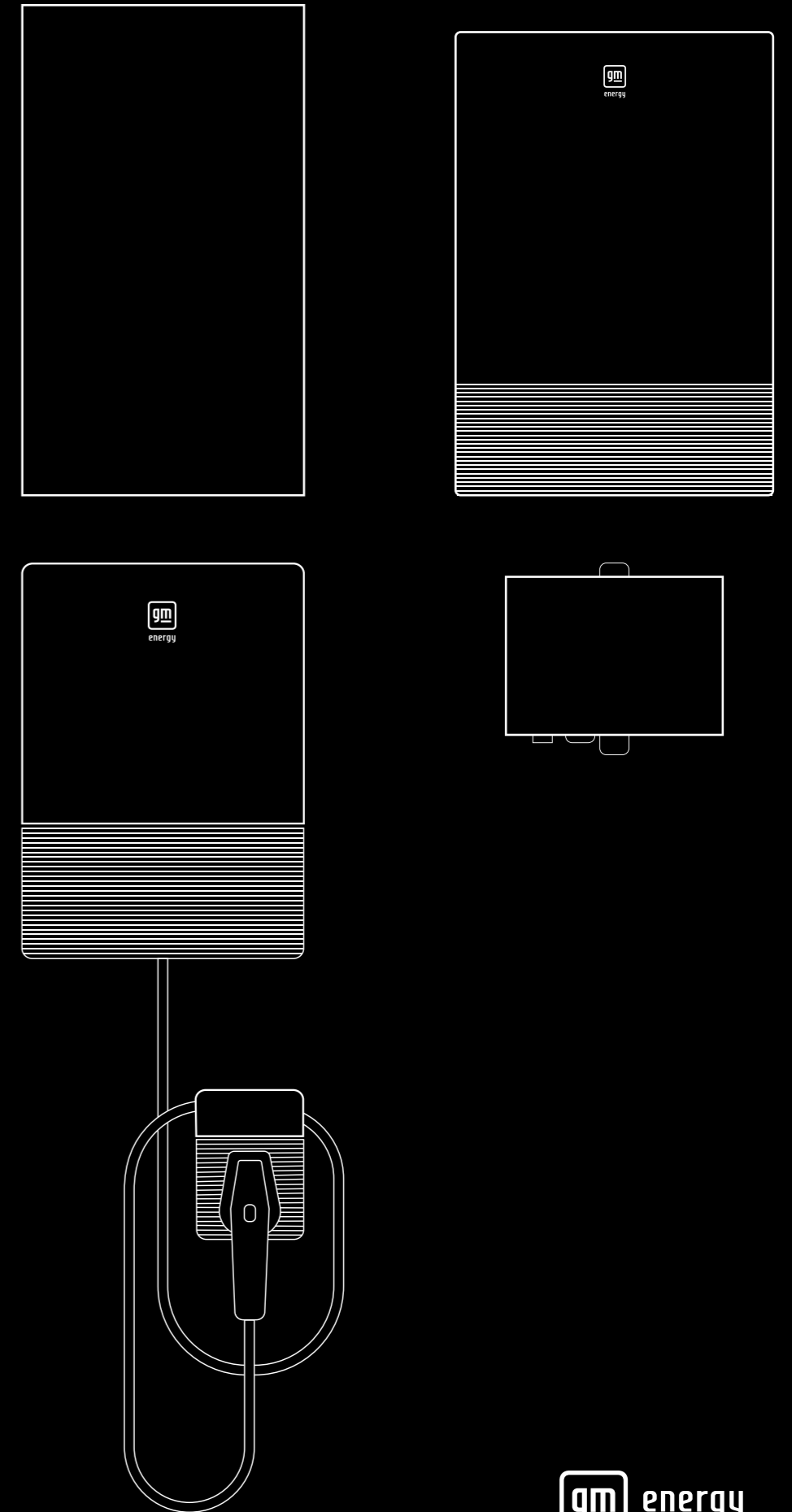
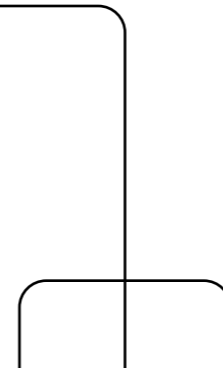

IMPORTANT SAFETY INSTRUCTIONS

Save These Instructions

To prevent the risk of PROPERTY DAMAGE, SERIOUS INJURY or DEATH, read and follow all warnings, safety precautions and instructions in this User Manual, each component Installation and Operation Manual, and your GM EV Owner's Manual. Keep this User Manual for future reference.

The GM EV charging solution should be installed only by a licensed contractor and/or a licensed electrician in accordance with all applicable state, local and national electrical codes and standards.

After installation, it's recommended that your system is connected and commissioned with a secure Wi-Fi network.

In the event of a fire in or around the components, evacuate the premises and contact local emergency services.

WARNING

Please read the instructions carefully and follow all safety precautions in each Installation and Operation manual before using these products. Access these manuals on the GM Energy website <https://gmenergy.com/for-home/installation-support>

WARNING

To reduce risk of fire, electric shock or serious injury:

- Do not attempt to open any equipment unless otherwise directed by this user manual.
- Do not attempt to use any part of the system or fix/alter the components if the system appears physically damaged. Contact the GM Energy Customer Support Center
- Do not store any flammable liquids or gases near the system or its components
- Do not expose any of the equipment to direct flames
- Do not submerge the equipment in water
- Do not use high-pressure water to clean the equipment
- Do not clean the equipment with harsh cleaning chemicals
- Do not remove any labels from the system or installed components
- Do not place foreign objects on top of any of the installed components
- Do not lean any foreign objects on any of the installed components
- Ensure proper clearances are maintained in the area surrounding the installed components
- Ensure components are installed and maintained in areas with proper ventilation
- Do not attempt to alter the wiring of the components. Incorrect wiring can lead to high-voltage exposure

WARNING

The GM Energy Home equipment should not be used as a primary or backup power source for medical equipment or any other products in which failure could lead to injury or loss of life.

WARNING

To reduce the risk of strangulation, keep small children away from the cord of the Charging Coupler and ALWAYS stow the Charging Coupler after use.

CAUTION

Do not paint the components. Changing the color of the external-facing surfaces can degrade the product life.

Federal Communications Commission Interference Statement

This device complies with Part 15 of the FCC Rules. Operation is subject to the following two conditions: (1) This device may not cause harmful interference, and (2) this device must accept any interference received, including interference that may cause undesired operation.

This equipment has been tested and found to comply with the limits for a Class B digital device, pursuant to Part 15 of the FCC Rules. These limits are designed to provide reasonable protection against harmful interference in a residential installation. This equipment generates, uses and can radiate radio frequency energy and, if not installed and used in accordance with the instructions, may cause harmful interference to radio communications.

However, there is no guarantee that interference will not occur in a particular installation. If this equipment does cause harmful interference to radio or television reception, which can be determined by turning the equipment off and on, the user is encouraged to try to correct the interference by one of the following measures:

- Reorient or relocate the receiving antenna
- Increase the separation between the equipment and receiver
- Connect the equipment into an outlet on a circuit different from that to which the receiver is connected
- Consult the dealer or an experienced radio/TV technician for help

FCC Caution: Any changes or modifications not expressly approved by the party responsible for compliance could void the user's authority to operate this equipment.

This transmitter must not be co-located or operated in conjunction with any other antenna or transmitter.

Radiation Exposure Statement:

This equipment complies with FCC radiation exposure limits set forth for an uncontrolled environment. This equipment should be installed and operated with minimum distance of 20 cm between the radiator and your body.

GETTING TO KNOW YOUR SYSTEM

Each Component Has a Job

Your GM Energy V2H Bundle delivers a comprehensive **bidirectional** charging experience that can power both your Compatible GM EV and, in the event of a power outage, your home. These components have been designed to work together in a safe, convenient and reliable way, but each has a specific job to do.

GM Energy PowerShift e1.19

- Includes the Charging Coupler and Charging Holster
- Manages the transfer of electricity to and from your Compatible GM EV
- Is capable of up to 19.2-kW charging power
- Can send up to 9.6 kW of discharge power to your home during a temporary outage when paired with the GM Energy V2H Enablement Kit and a properly equipped GM EV

 **Note:** Depending on a residence's power needs, certain appliances, utilities and circuits may not be powered during an outage.

The GM Energy V2H Enablement Kit

- Includes the GM Energy Home Hub e1.200, GM Energy Inverter e1.11 and GM Energy Dark Start Battery Delta9.6V25Ah
- Enables your Compatible GM EV to act as a battery that can send power to your properly equipped home (sometimes referred to as "backup mode")
- Only works when paired with a GM EV equipped with bidirectional technology and the GM Energy PowerShift Charger

More information about each component follows.

GM Energy Home Hub



GM Energy Inverter

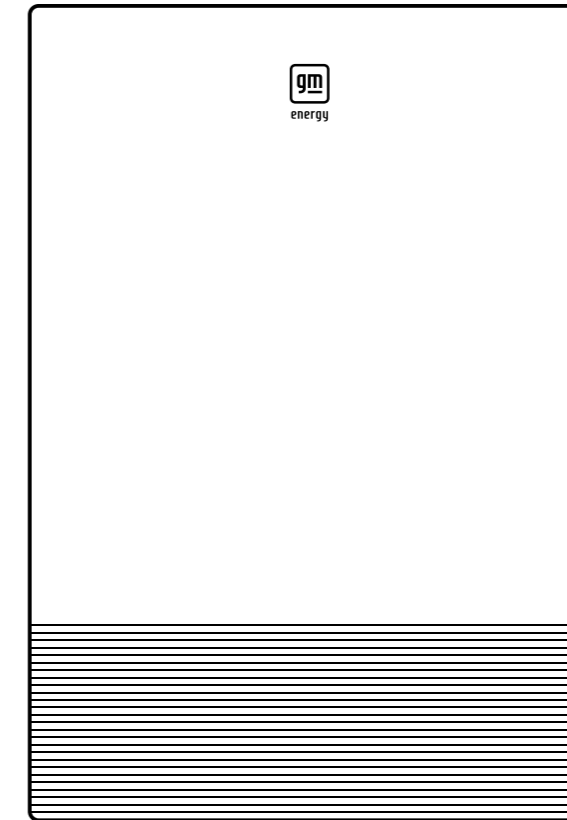

GM Energy PowerShift Charger

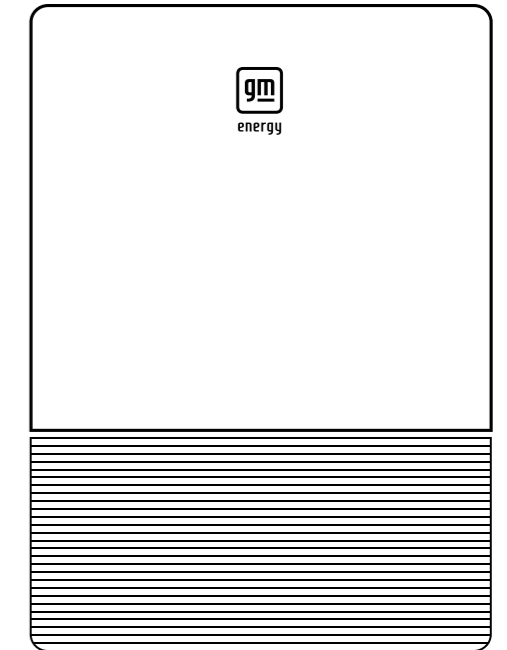

GM Energy Dark Start Battery

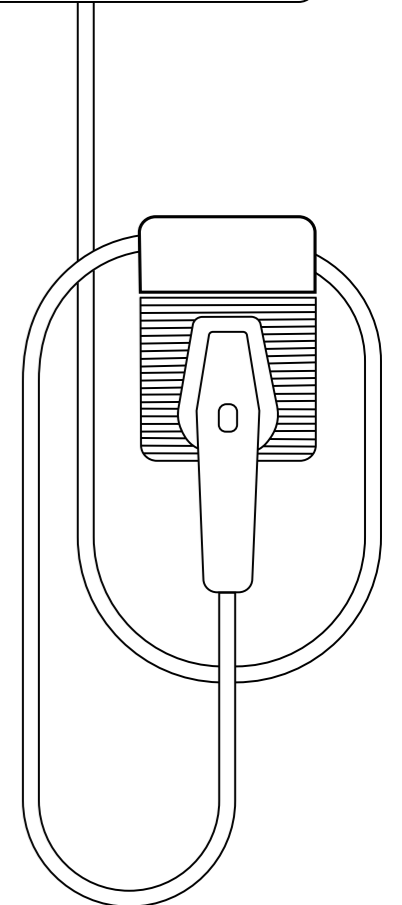
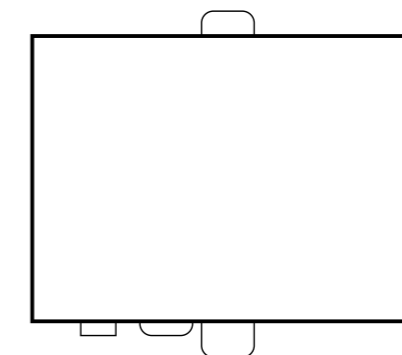

GETTING TO KNOW YOUR SYSTEM

GM Energy PowerShift Charger

Understanding how it works

Your GM Energy PowerShift Charger uses electricity from your home to charge the batteries in your GM EV. When paired with the GM Energy V2H Enablement Kit and a Compatible GM EV, it also manages the bidirectional power transfer needed to send power to your home during an outage (also referred to as “discharging”). If you leave your Compatible GM EV plugged in and have enabled the backup power feature, it will be ready in the event of a power outage.

1. **LED Indicator** – Found on the front of the GM Energy PowerShift Charger (on the right side), it flashes different colors and codes to indicate its operating mode. (See the [Decoding the Blinking LED Lights](#) section)
2. **Power Button** – Found on the right side of the charger; press this to stop or start a charging or discharging session at any time

3. **Charging Coupler** – The device attached to the cord that connects the GM Energy PowerShift Charger to a GM EV. When the coupler is discharging energy back to your home, it will automatically lock into position in your GM EV’s charging port. (See the [Charging Your GM EV](#) section)
4. **Charging Holster** – Mounted on the wall adjacent to the GM Energy PowerShift Charger, it provides a safe, convenient place to stow the Charging Coupler when it is not being used. You can loop the power cord around the holster and then rest it on top or securely plug it in

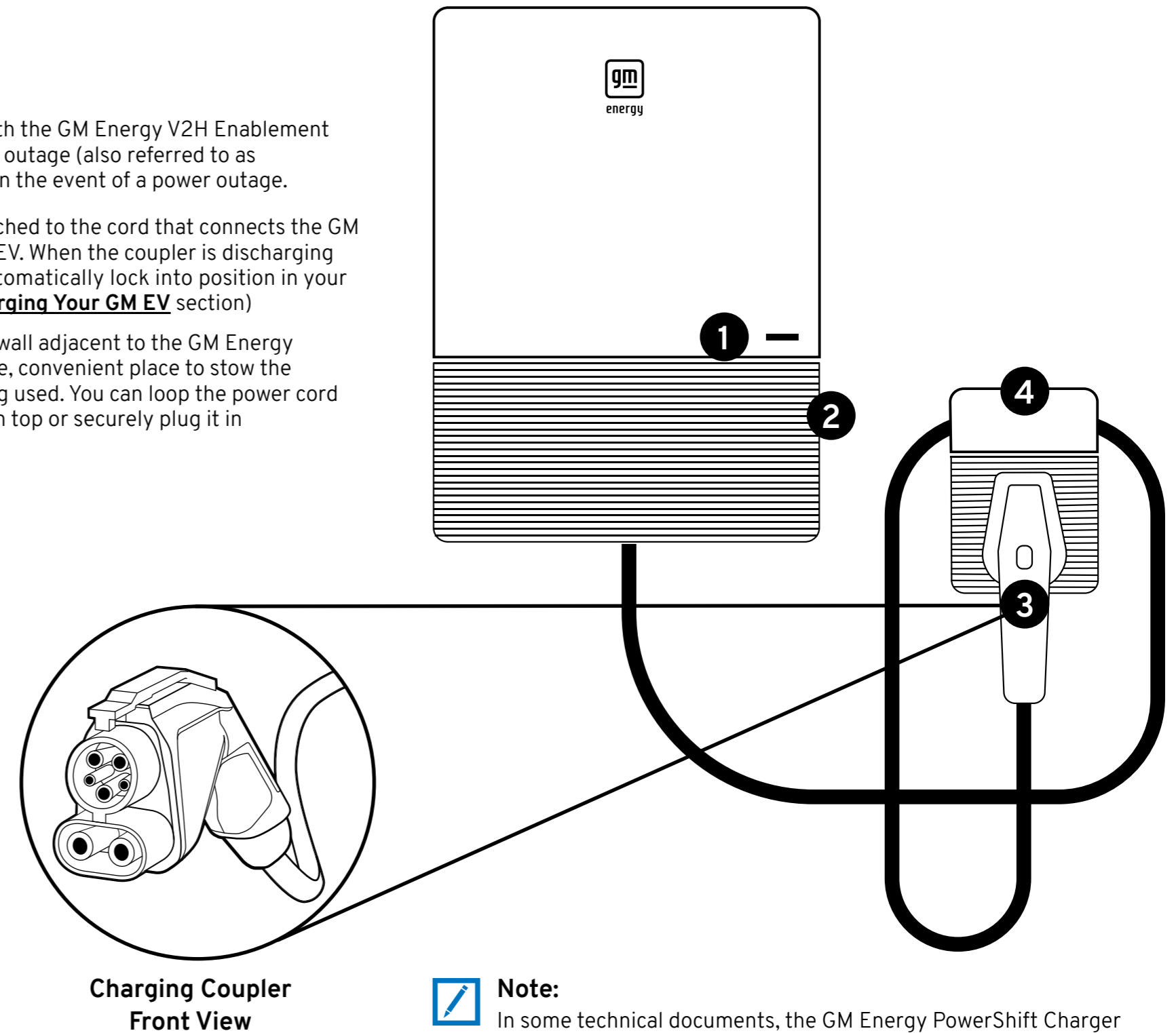

 **Note:** In some technical documents, the GM Energy PowerShift Charger may be referred to as **EVSE** (Electric Vehicle Supply Equipment).

GETTING TO KNOW YOUR SYSTEM

GM Energy Home Hub

⚠ WARNING

The GM Energy Home equipment should not be used as a primary or backup power source for medical equipment or any other products in which failure could lead to injury or loss of life.

During a power outage, the GM Energy Home Hub safely disconnects your home from the local power grid and enables backup power to flow from the GM Energy Inverter throughout your home. The GM Energy Home Hub has circuit breakers inside just like a main service panel.



Note:

Depending on your home's unique installation, certain appliances or circuits may not be powered during backup power mode.

You determine your experience

- The GM Energy Home Hub can be installed using a number of configurations. When your system was installed, your installer should have walked you through the modifications that were made to your home's electrical system
- For more information on your system's unique setup, view the inside cover of the GM Energy Home Hub. For further information, contact your installer or the GM Energy Support Center
- To optimize your experience, consider which appliances draw a lot of power or are prone to power surges so that you can avoid disrupting the discharging session

Find more information about how to check the GM Energy Home Hub in [Troubleshooting Tips](#).



Note:

In some technical documents, the GM Energy Home Hub may be referred to as an **MID** (Microgrid Interconnect Device).

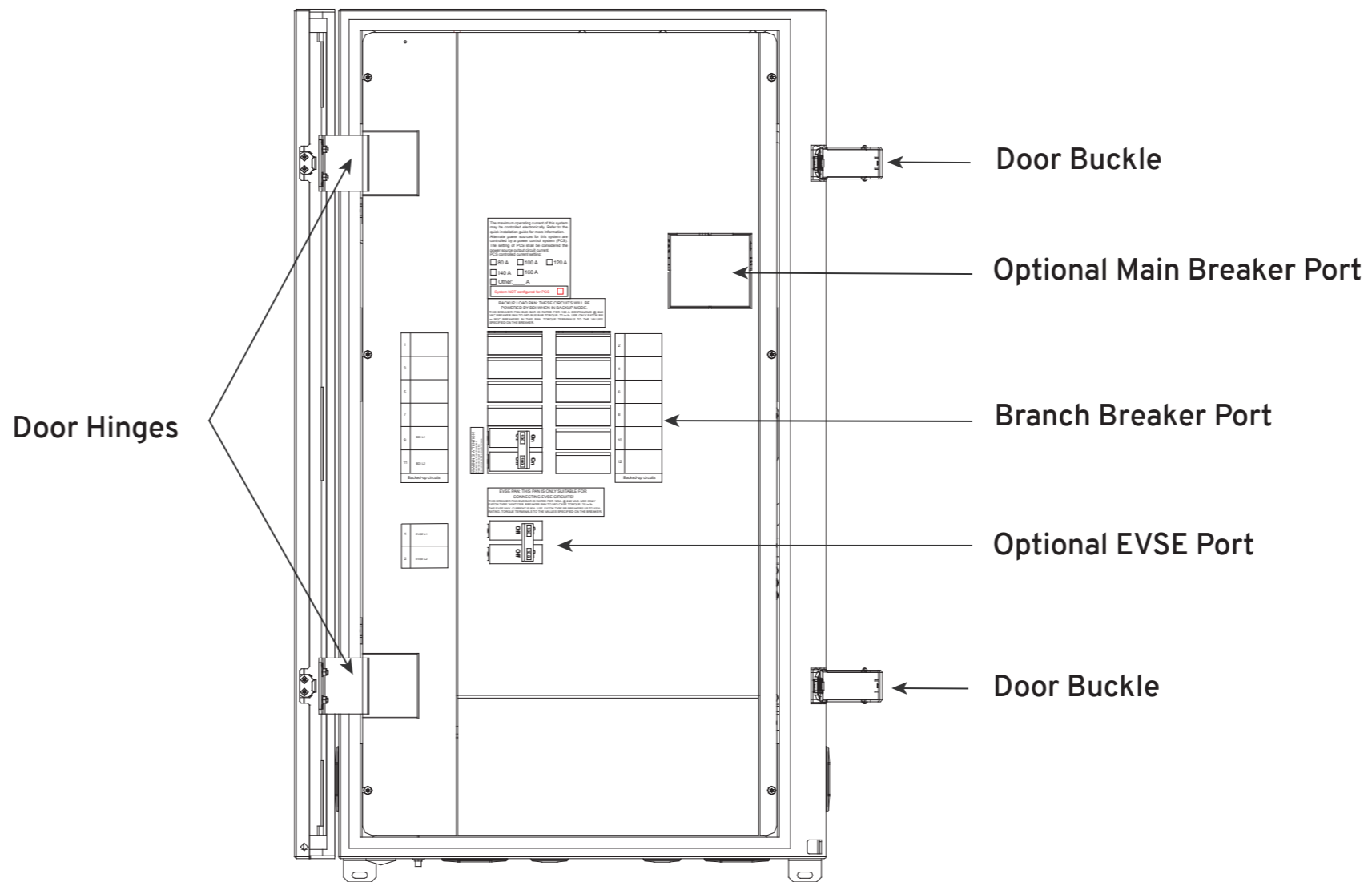

Note:

Latches on the GM Energy Home Hub door have been fitted with covers; users may remove covers if desired.

GETTING TO KNOW YOUR SYSTEM

GM Energy Inverter

In general terms, an inverter is an electrical system that converts between **direct current (DC) power** from a battery, solar panel or electric vehicle and **alternating current (AC) power** that can be safely used to power homes, appliances and other electrical devices. Your GM Energy Inverter is also designed to regulate how much power is being discharged from a Compatible GM EV during an outage.

The LED Indicator

- Located on the front panel
- Indicates your GM Energy Inverter's performance status by flashing different colors and codes that denote its operating mode
- When fully operational, the LED will display a solid green light (Find more information in the [Decoding the Blinking LED Lights](#) section)



Note:

In some technical documents, the GM Energy Inverter may be referred to as a **BDI** (Bidirectional Inverter).

Future GM Energy products

You may notice buttons and controls on the bottom of the inverter; these are only used if you have integrated those products (sold separately).*

- Contact GM Energy for more information regarding the capabilities of the GM Energy Inverter

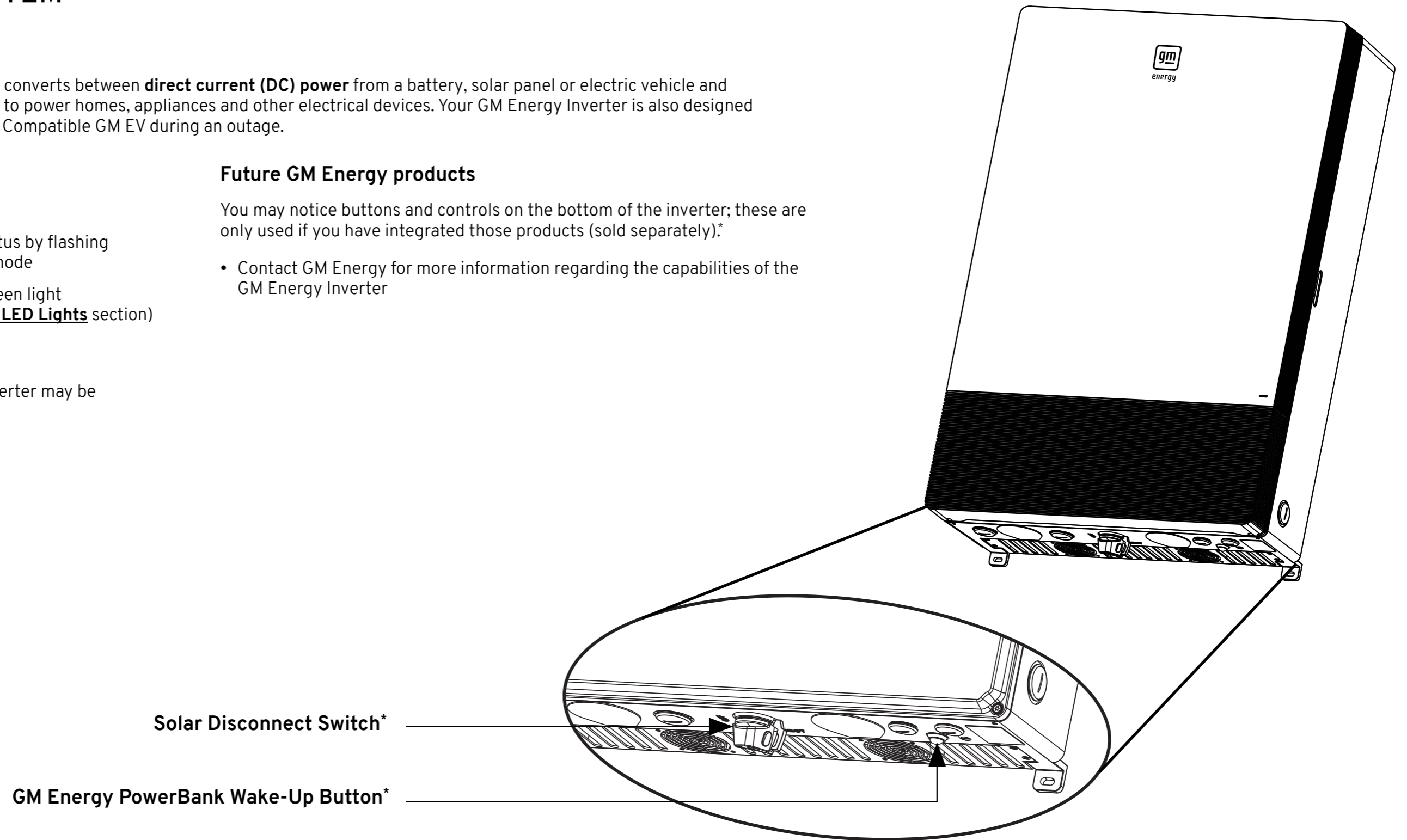

*Additional system enhancements may be required; to learn more about integrating future GM Energy products, visit the GM Energy Live website (<https://gmenergy.gm.com/for-home/resources-and-support>) or contact the GM Energy Customer Support Center.

GETTING TO KNOW YOUR SYSTEM

GM Energy Dark Start Battery

The primary job of the GM Energy Dark Start Battery is to provide sufficient energy to allow components of your GM Energy V2H Bundle to communicate with your Compatible GM EV once it has been plugged in.

Why it's important

- If your Compatible GM EV isn't plugged in when a power outage occurs, your charging system still needs electricity to properly function
- During a power outage, the GM Energy Dark Start Battery keeps your system awake so it can communicate with the Compatible GM EV
- After 10 minutes without a Compatible GM EV connection, the GM Energy Dark Start Battery will go into deep sleep mode to conserve energy
- If you plug in your GM EV more than 10 minutes after the power went out, simply press the Power Button on the side of the GM Energy PowerShift Charger to wake up the system
- If possible, do not let the home sit unpowered for more than two consecutive days; it is possible the GM Energy Dark Start Battery will fully deplete and not be able to communicate with the Compatible GM EV when you plug it in
 - If this occurs, grid power needs to be restored before the GM Energy Dark Start Battery can be recharged and wake up the charging system
- Most users will never need to interact directly with the GM Energy Dark Start Battery (Find more information in the [Need-to-Know Action Items](#) section)

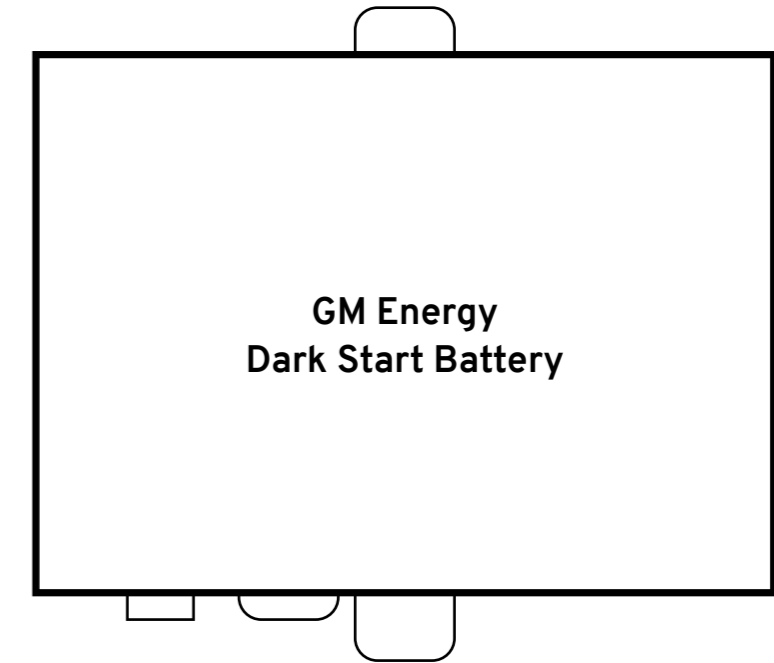

NEED-TO-KNOW ACTION ITEMS

WARNING

To reduce the risk of strangulation, keep small children away from the cord of the Charging Coupler and ALWAYS stow the Charging Coupler after use.

Charging Your GM EV

The front of the GM Energy PowerShift Charger has a small LED Indicator light that flashes in different colors and patterns to signal the charging status. When the circuit breaker is first turned on, this light will blink with a white light. When it stops blinking, the charger is ready. Now you can begin charging your GM EV. (Find more information in the [Decoding the Blinking LED Lights](#) section.)

- Fully uncoil the cord of the Charging Coupler from the Charging Holster
- Plug the Charging Coupler into your GM EV's charging port by pushing it into your GM EV's charging outlet until it clicks
- The LED light on the GM Energy PowerShift Charger will blink on and off with a green light, indicating a charging session is in progress
- When the green LED stops blinking, the GM EV has completed its charging session
- If you are ready to drive, disconnect the Charging Coupler and secure it safely on the Charging Holster. Otherwise, leave the Compatible GM EV plugged in so that it's always ready in case of a power outage

NEED-TO-KNOW ACTION ITEMS

WARNING

To reduce risk of fire, electric shock or serious injury, inspect the system for any damage. Do not attempt to use any part of the system or fix/alter the components if the system appears physically damaged.

The Power Goes Out – Your GM EV Was Plugged In

- If your Compatible GM EV is plugged in and set to “Automatic Backup Power” in your Compatible GM EV’s mobile app (myChevrolet, myBuick, myGMC or myCadillac) – even if it is not fully charged – the GM Energy V2H system will begin discharging energy to your home as soon as it recognizes a power outage. Once you have identified your home charging location in the vehicle screen or mobile app, no further action is needed (Find more information in the [Using Your GM EV’s Mobile App](#) section)
- A solid blue LED light on the GM Energy PowerShift Charger indicates the bidirectional charging system is initiating a backup power session (this should take less than one minute)
- A slowly blinking green light (one second on, four seconds off) indicates that power is being directed to your home
- Once power is restored, your GM EV will automatically end the discharge session and begin charging (indicated by the steadily blinking green LED light)

WARNING

To reduce the risk of electric shock or serious injury, do not forcibly remove the GM Charging Coupler from the vehicle.

- If you wish to end the discharge session while the power is out, press the Power Button on the right side of the GM Energy PowerShift Charger to end the session. You can also send a command to end the discharging session through your GM EV’s mobile app. Once the power is off, you can disconnect the Charging Coupler from the GM EV

Troubleshooting

If the Compatible GM EV does not begin to automatically discharge power to your home, try these troubleshooting actions.

- Make sure the Compatible GM EV is properly plugged in
- If the system has been without power for more than 10 minutes, it may be in Deep Sleep Mode. Wake up the system by pressing the Power Button on the side of the GM Energy PowerShift Charger
- **Automatic Backup Power** – Once you have identified your home charging location in the vehicle screen or the mobile app, make sure you have enabled Automatic Backup Power on your GM EV by checking your Compatible GM EV’s mobile app (myChevrolet, myBuick, myGMC or myCadillac)
- **Vehicle Battery Reserve Level** – Check your battery reserve level. The system is designed to stop sending power to your home once your GM EV has reached its **range** reserve percentage (the discharge threshold to maintain a minimum charge on your GM EV). Battery reserve level and charging status can be monitored using your Compatible GM EV’s mobile app (myChevrolet, myBuick, myGMC or myCadillac) (Find more information in the [Using Your GM EV’s Mobile App section](#))
- Check your Compatible GM EV’s mobile app (myChevrolet, myBuick, myGMC or myCadillac) to see if your GM EV has reached the battery reserve level*

*The battery reserve default level is 20%. Reserve level adjustments are dependent on your specific GM EV. Consult your GM EV Owner Manual or mobile app for more information.

NEED-TO-KNOW ACTION ITEMS

WARNING

To reduce risk of fire, electric shock or serious injury, inspect the system for any damage. Do not attempt to use any part of the system or fix/alter the components if the system appears physically damaged.

The Power Goes Out – Your GM EV Wasn’t Plugged In

What if you arrive home and discover the power is out? For the first 10 minutes of a power outage, the LED on the GM Energy PowerShift Charger shows a solid white.

- Simply plug the Charging Coupler into your Compatible GM EV to connect it to the GM Energy PowerShift Charger
- The LED should switch to solid blue
- Less than a minute later, the power should come on in your home and the LED will begin slowly blinking green to indicate your GM EV is sending power to your home

What if you arrive home, the power is out and the LED light on the GM Energy PowerShift Charger is off?

- Your system is doing what it’s supposed to do – it has gone into Deep Sleep Mode
- See the next section on how to wake up the system

Troubleshooting

If power is out longer than 10 minutes, the system will go into Deep Sleep Mode to preserve the energy stored in the GM Energy Dark Start Battery. You can confirm that your system is in Deep Sleep Mode by checking to see that a blinking white LED light has appeared on the GM Energy Inverter.

- To wake the system, make sure your Compatible GM EV is plugged in and then press the Power Button on the right side of the GM Energy PowerShift Charger
- The Compatible GM EV will begin discharging energy to your home, indicated by a blue light on the GM Energy PowerShift Charger’s LED, followed by a slowly blinking green light (Find more information in the [Decoding the Blinking LED Lights](#) section)
- Extended Power Outage – If you’ve been away in your GM EV for a couple days and then discover the power is out in your home (you can always check this using the mobile app), start by plugging the Compatible GM EV in
- If there is still no LED light on the GM Energy PowerShift Charger, press the Power Button on the right side of the GM Energy PowerShift Charger to wake the system
- If there is sufficient reserve energy in the GM Energy Dark Start Battery, the Compatible GM EV will begin discharging energy to your home, indicated by a blue light on the LED followed by a slowly blinking green light (one second on, four seconds off)
- If no light appears, it’s possible the power has been out in excess of two days and the GM Energy Dark Start Battery is depleted
- Once power is restored to your home, you will be able to restart the GM Energy V2H Bundle by plugging in your GM EV and pressing the Power Button on the GM Energy PowerShift Charger

NEED-TO-KNOW ACTION ITEMS

Troubleshooting Tips

⚠ WARNING

Do not attempt to use any part of the system or fix/alter the components if the system appears physically damaged. Contact the GM Energy Customer Support Center for help at 1-833-64POWER.

Here are some typical scenarios you might encounter, with simple, do-it-yourself fixes to try. Know that you can always call the GM Energy Customer Support Center for any reason.

My Compatible GM EV was sending power to my home but then power suddenly kicked off.

- Your Compatible GM EV may have reached its preset battery reserve level. Check your mobile app. If this is the case, you can wait for the power to come back. You can also go to an alternate location to charge up your Compatible GM EV and then initiate a new discharge session
- You may have plugged in something that caused a surge in the power draw – such as a compressor, hair dryer or AC unit – which overloaded the system
 - Verify the system is overloaded by looking for a blinking red light on the GM Energy Inverter. This indicates that more power is being drawn than the system can handle (Find more information in the [Decoding the Blinking LED Lights](#) section)
- The system is designed to restore power automatically and will keep trying to restart in brief intervals (starting at 10 seconds with a 10-second increase with each passing interval). If the power turns on but then kicks back off, try unplugging the appliance most recently used. Or, if you prefer, turn off other devices drawing large amounts of power. The solution is to lower your total power consumption so that the system stays on
- If the session does not start back up automatically, consider unplugging and plugging in the Compatible GM EV again



Note:

If your concern relates to a blinking LED light, see the next section on [Decoding the Blinking LED Lights](#).

My backup power is working, but only some of the circuits or appliances in my home have power.

It is possible that these circuits or appliances are not designed to work during a backup power session. Your installer should communicate which circuits will and will not work during backup power mode. If the circuit should be working during backup mode, it is possible the circuit breaker has tripped.

- If only some appliances don't have power, it could indicate a tripped circuit breaker. Circuit breakers are designed to shut off whenever something tries to draw more power than the wires can safely handle
- Check for tripped circuit breakers on the GM Energy Home Hub or the other electrical panels in your home
- Open the front cover of your GM Energy Home Hub to see if you've tripped a circuit. You may need a 1/8-inch Allen wrench or screwdriver to flip open the two latches securing the cover
- The GM Energy Home Hub has labels inside the cover to tell you what each circuit controls (This was determined by your installer at installation)
- If a circuit breaker has been flipped off, check the label to identify the source of trouble
- Investigate and turn off or unplug anything that could be putting excessive demand on that line
- If your Compatible GM EV is still plugged in, the backup session should restart automatically. If the backup session does not restart, please unplug and plug back in
- You may need to press the Power Button on the GM Energy PowerShift Charger to wake up the system
- If you have tried troubleshooting on your own and still experience issues with your system, contact the GM Energy Customer Support Center for help

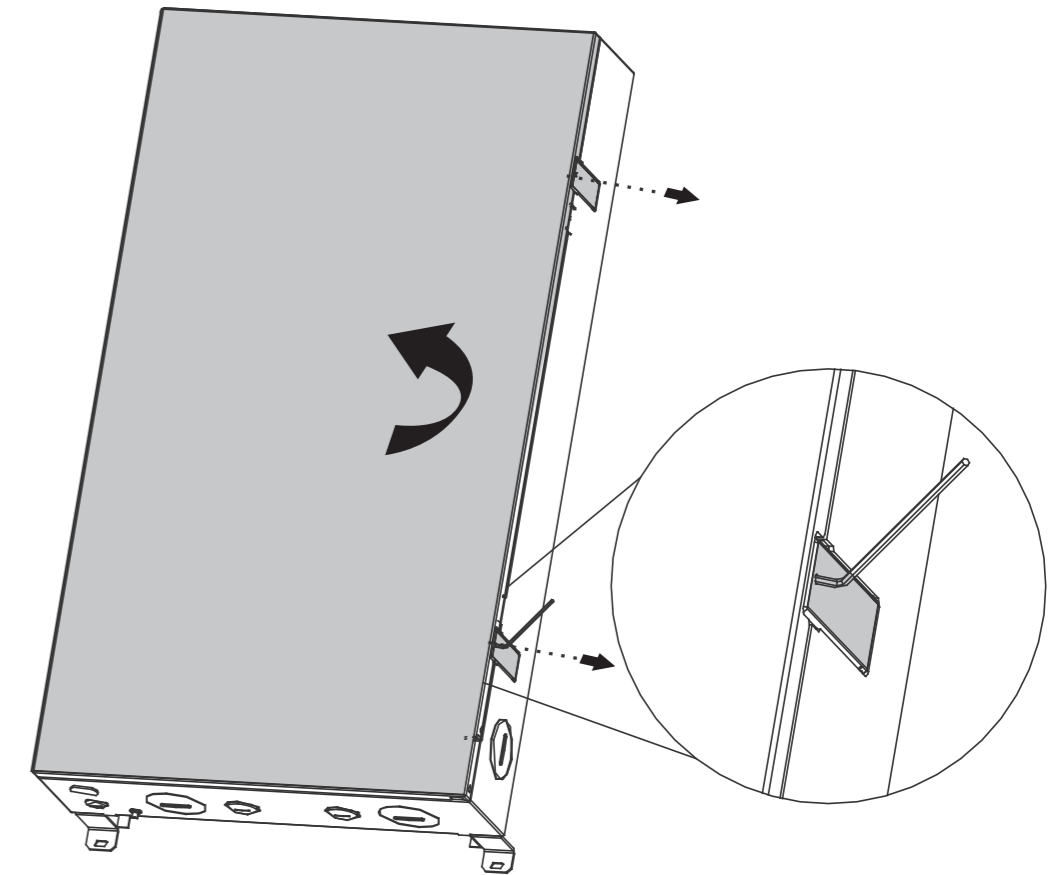

Note:

Latches on the GM Energy Home Hub door have been fitted with covers; users may remove covers if desired.

NEED-TO-KNOW ACTION ITEMS

My power came back on, but only some of the circuits or appliances in my home have power.

If you still have issues, it's possible that a regular home circuit breaker was tripped (when the home was not in backup mode).

- Check your home's circuit board to reset any tripped circuit breakers
- Turn off any appliances that may be causing an excessive power draw

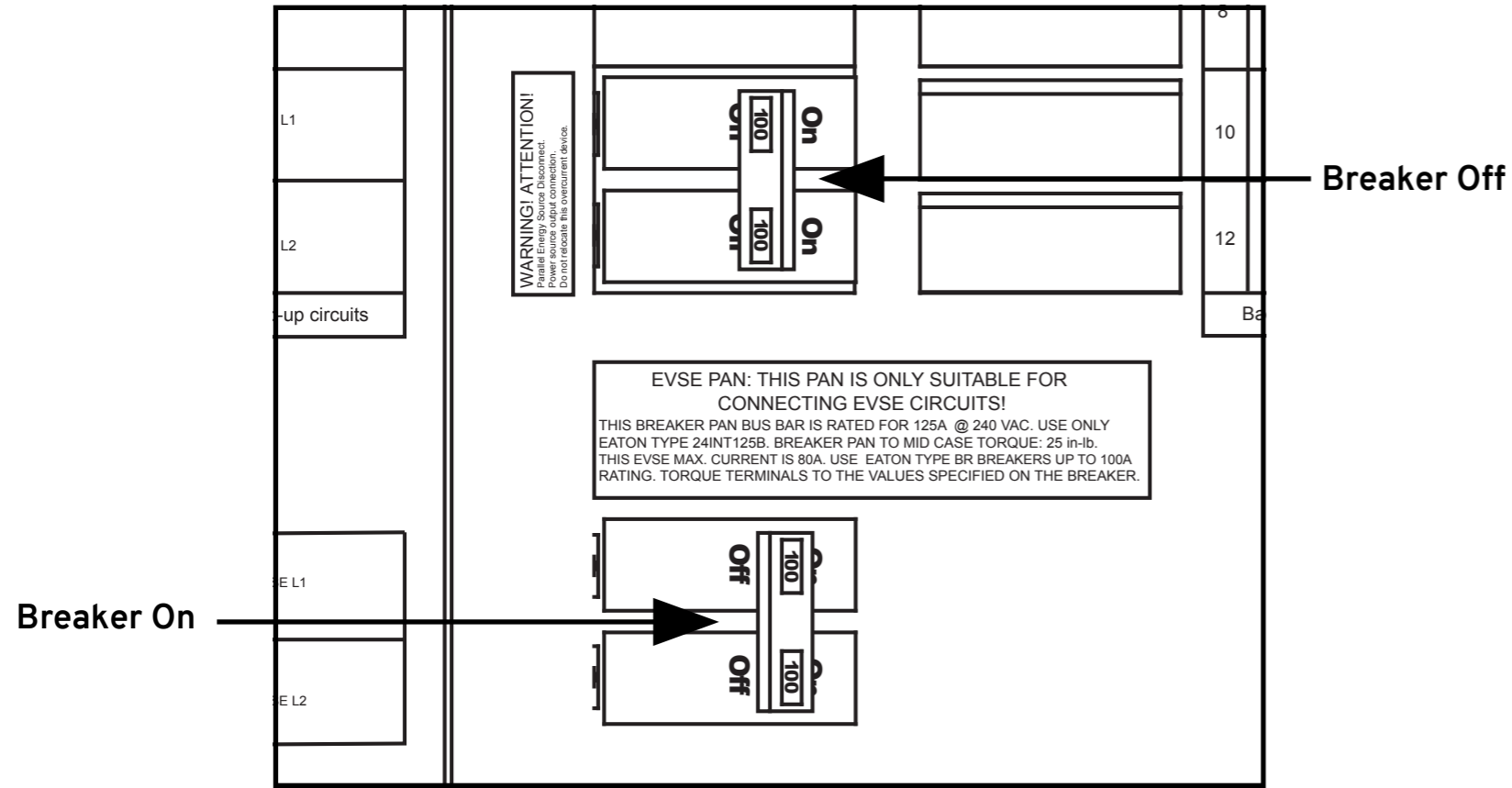

⚠️ WARNING

Intentionally flipping circuit breakers installed in the GM Energy Home Hub to their “on” position with home appliances or loads connected to the breaker could cause a fire, which may result in serious personal injury, loss of life or property damage. Turn off any appliances or devices that are causing excessive draw to return to normal operation.

⚠️ CAUTION

If you have any questions regarding your home's electrical system, contact a professional electrician. If there are any problems with the performance of the GM Energy V2H System, call the GM Energy Customer Support Center for help at 1-833-64POWER.

My power is out, but my Compatible GM EV is not starting a backup power session.

- If the GM Energy PowerShift Charger LED light remains solid blue for more than a minute and no session begins, it is likely the vehicle enablement conditions are not met
- Vehicle enablement conditions are: valid state of charge (SOC above 20%), Automatic Backup Power enabled in app, home location set and vehicle is at home location



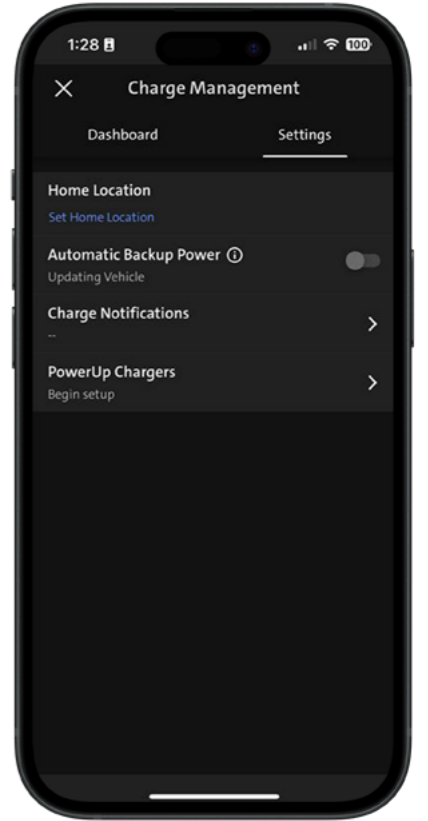

If you have met all vehicle enablement conditions and the backup power session still hasn't started, it is possible your Compatible GM EV is not registering its home location properly. Ensure your mobile app shows Home in the charge management section.



NEED-TO-KNOW ACTION ITEMS

Decoding the Blinking LED Lights

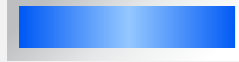
Both the GM Energy PowerShift Charger and the GM Energy Inverter feature LED Indicators that signal the system's charge status.

GM Energy PowerShift Charger LED Indicator			
Color	Behavior	Definition	Recommended Action
 White	Blinking	Charger is resetting	No action required
	Solid	Charger is ready but GM EV is not plugged in	Plug in GM EV
 Green	Steadily Blinking (1 second on, 1 second off)	GM EV is actively charging	No action required
	Slowly Blinking (1 second on, 4 seconds off)	Compatible GM EV is actively discharging power to the home	No action required
	Solid	Compatible GM EV is plugged in but not actively charging or discharging	No action required. (Leave Compatible GM EV plugged in until you need to drive, so that it's ready in case of a power outage)
 Blue	Solid	Bidirectional charging system is in process of switching from charging to discharging session	No action required
 Yellow	Blinking	OTA (over-the-air) software update is in progress	No action required
 Red	Blinking	Charger error	Check your Compatible GM EV's mobile app (myChevrolet, myBuick, myGMC or myCadillac) for further descriptions. Attempt to unplug and plug in the charging coupler again. If issue persists, or if physical damage is noticeable to the system, please call the GM Energy Support Center before proceeding
	Solid	Installation incomplete	Contact installer

GM Energy PowerShift Charger

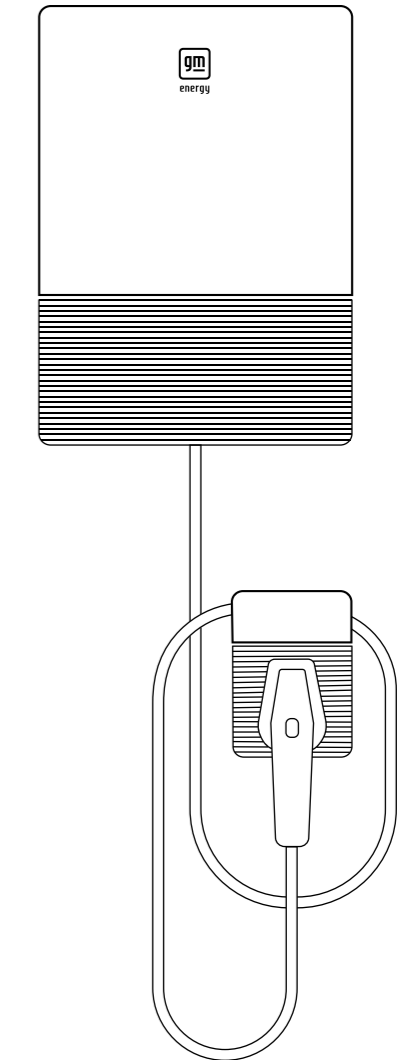

WARNING





A red LED light indicates an error or issue that may cause a hazardous situation.

To reduce the risk of fire, electric shock or serious injury, do not attempt to open any equipment or fix/alter any components, and follow the recommended action noted.

 **Note:** If the LED Indicator on the GM Energy PowerShift Charger is completely off, the system is not receiving power (it is in Deep Sleep Mode).

NEED-TO-KNOW ACTION ITEMS

Decoding the Blinking LED Lights

GM Energy Inverter LED Indicator			
Color	Behavior	Definition	Recommended Action
 White	Steadily Blinking (1 second on, 1 second off)	OTA (over-the-air) software update is in progress	No action required
	Slowly Blinking (1 second on, 4 seconds off)	Deep Sleep Mode	Plug in GM EV and press Power Button
	Solid	GM Energy Inverter is initializing after a reset	No action required
 Green	Steadily Blinking (1 second on, 1 second off)	A charge or discharge session is starting up	No action required
	Slowly Blinking (1 second on, 4 seconds off)	Idle/standby	No action required
	Solid	Normal operation – the system is converting power	No action required
 Yellow	Steadily Blinking (1 second on, 1 second off)	Battery fault mode (GM Energy PowerBank or GM Energy Dark Start Battery)	Try pressing the red button at the bottom of the GM Energy Inverter. If the light remains yellow, call the GM Energy Support Center
	Slowly Blinking (1 second on, 4 seconds off)	GM Energy Inverter warning	Contact the GM Energy Support Center
	Solid	Equipment alarm	Contact the GM Energy Support Center
 Red	Irregular Blinking (0.5 seconds on, 0.5 seconds off, 2 seconds on, 0.5 seconds off)	Over current protection fault – more power is being drawn than the system can handle (such as by an AC unit, welding kit, etc.)	Try turning off appliances and devices to lower your current energy consumption. The backup power session should restart automatically. If the session does not start back up automatically, consider unplugging and plugging in the Compatible GM EV again
	Rapid Blinking	Ground fault – indicates a possible wiring issue	Call the GM Energy Support Center
	Solid	Arc fault – indicates a possible wiring issue	Call the GM Energy Support Center

GM Energy Inverter

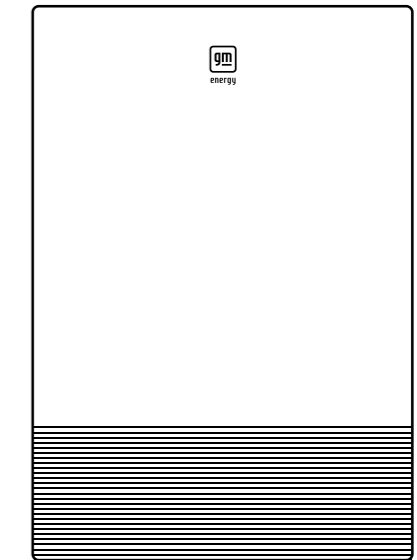

WARNING

A red LED light indicates an error or issue that may cause a hazardous situation.

To reduce the risk of fire, electric shock or serious injury, do not attempt to open any equipment or fix/alter any components, and follow the recommended action noted.

USING YOUR GM EV'S MOBILE APP

Built into your vehicle's mobile app (myChevrolet, myBuick, myGMC or myCadillac)* is a dedicated interface between you and your GM Energy V2H Bundle. After your GM Energy V2H Bundle is installed and commissioned by your installer, you will need to download the app and complete the setup.



Note:

“Commissioned” refers to the step in the installation process that turns the system on, updates system settings and connects the system to your Wi-Fi network. After installation, it's recommended that your system is connected and commissioned with a secure Wi-Fi network. Final approval to operate may be dependent on inspections by local jurisdiction representatives.

Click on your brand icon
to download the app now! →



First-Time Setup

- If you haven't already, download your vehicle's mobile app (myChevrolet, myBuick, myGMC or myCadillac) and log in to the system using the account used to purchase your GM Energy V2H Bundle
- A link for your GM Energy System should appear on the app's home page (next to your vehicle) within 24 hours of **commissioning**
 - If you don't see a link, you can register your system by tapping the “Add Product” link on your account page and selecting your home energy product from the list
- Follow instructions on the app to register your system and connect to your home network and complete the guided setup
- Your V2H system password can be found in your GM Energy Home Hub Quick Installation Guide. If misplaced, the password is available by calling the GM Energy Customer Support Center
- If your hardware does not show up in your phone network settings, please reboot the system by pressing the Power Button on your charger for 10 seconds

Enabling Automatic Backup Power

- You can enable Automatic Backup Power for your Compatible GM EV by navigating to your GM EV Dashboard, selecting Charge Management and reviewing your Home Location Settings. Charge Management for your GM EV can also be accessed from your Home Energy Dashboard

Why You Need the App

This app is your essential connection to the GM Energy V2H Bundle, providing a dashboard for the current status of all related charging systems and components. You can use the app to:

- Confirm that Automatic Backup Power is enabled
- View the status of your GM EV's vehicle-to-home charging system
- See your estimated backup time if a power outage were to occur**
- See real-time charge and discharge power and home load consumption
- Review all of this real-time data when you are away from home or away from your GM EV, using user-friendly widgets that help you plan accordingly
- Configure wireless network settings

To take full advantage of this robust app, open it up and familiarize yourself with its many feature benefits.



Note:

For unique installations, your grid power reading in your app may not represent your total power imported from the grid. Check with your installer to confirm metering placement.

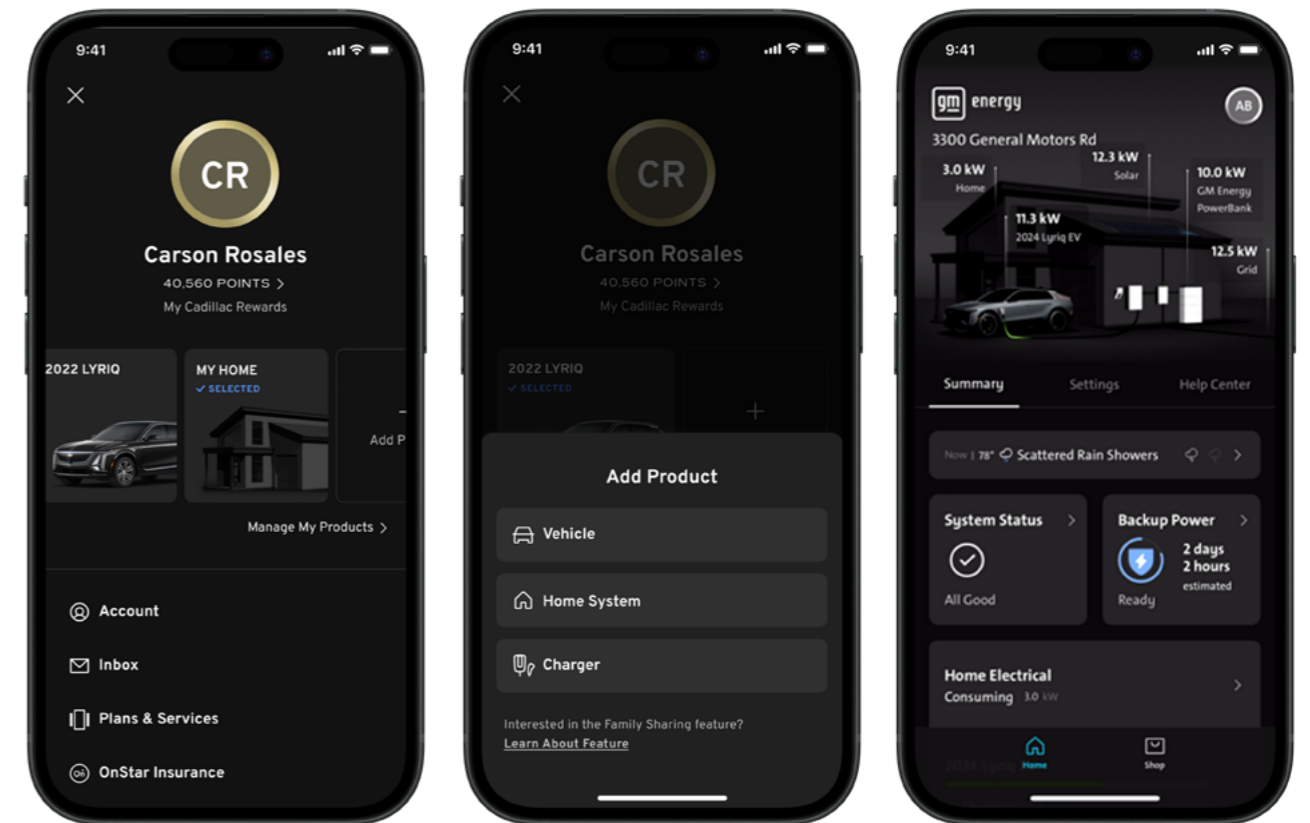

*Available on select Apple and Android devices. Service availability, features and functionality vary by vehicle, device and the plan you are enrolled in. Terms apply. Device data connection required. Actual images and features may vary and are subject to change. **Weather conditions, life of the battery, energy efficiency of appliances and other external factors may impact the duration of time. Results may vary. Length of time may vary depending on energy usage.

OVER-THE-AIR UPDATES (OTA)

The GM Energy System is designed to install software updates automatically, using wireless technology so as not to inconvenience the user. After the update is finished, the system will reboot. Depending on the type of update, the lights in the home may flicker briefly.

- Designed to work over the life of the system to improve features and fix minor bugs
- Is indicated by a yellow LED light on the GM Energy PowerShift Charger and a blinking white LED light on the GM Energy Inverter
- Triggers a notification in your vehicle's mobile app (myChevrolet, myBuick, myGMC or myCadillac) that an update is in progress
- The LED Indicators will return to a solid green light (if the GM EV is plugged in)
- If LED Indicators do not return to normal after two hours, please call the GM Energy Customer Support Center

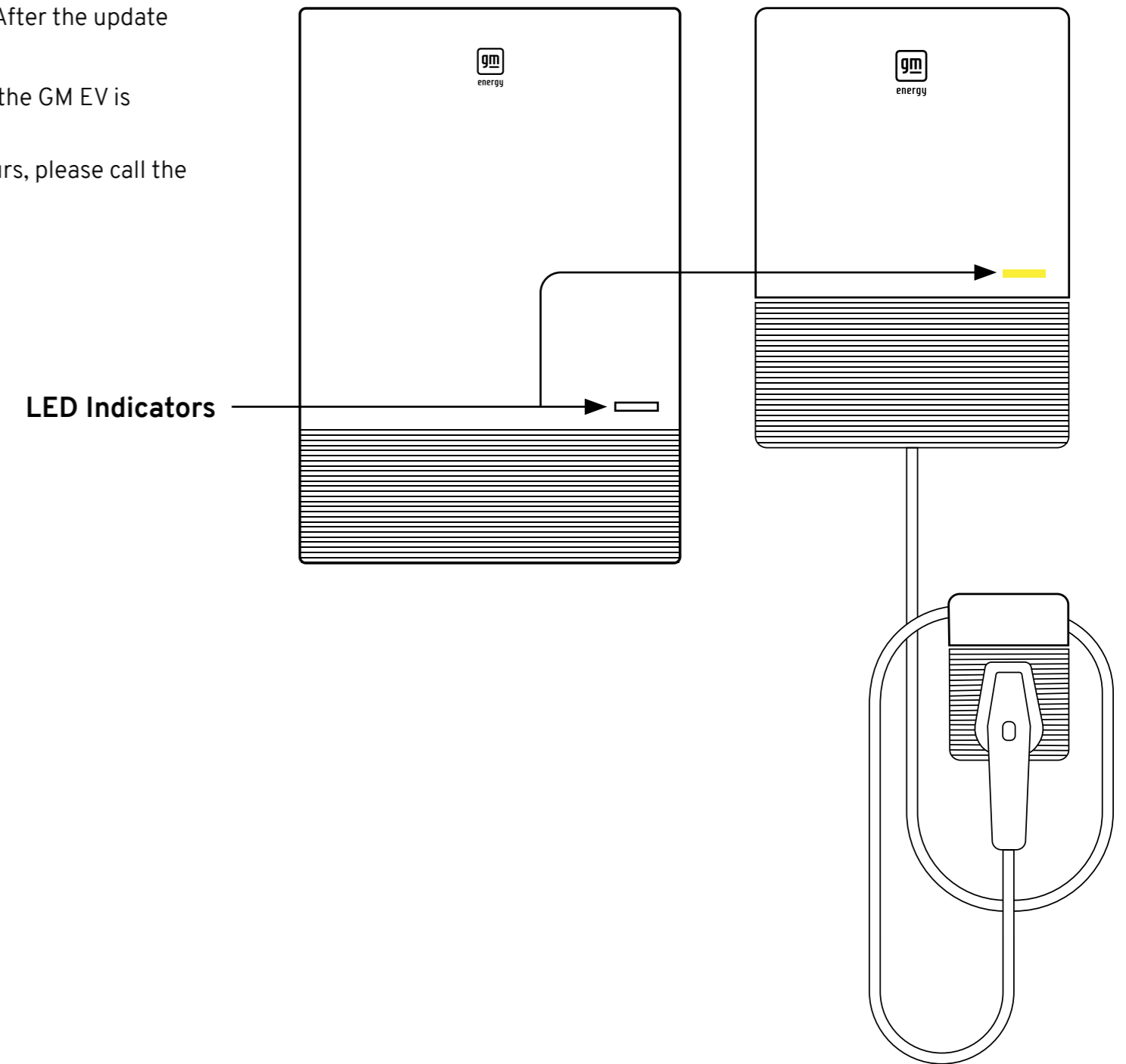

CARE AND MAINTENANCE

The GM Energy V2H System does not require any scheduled maintenance. However, make sure its components remain free from debris, ice or snow to optimize product longevity.

Helpful Resources

Call the GM Energy Customer Support Center at 1-833-64POWER.

- Monday – Friday: 8 a.m. – midnight ET
- Saturday – Sunday: Noon – 9 p.m. ET
- Outside business hours, customers can leave a voicemail or contact the support team via email at energyservice@gm.com

The GM Energy website is always available at

<https://gmenergy.gm.com/home/resources-and-support>

For issues specific to your GM EV, refer to:

- myChevrolet app
- myBuick app
- myGMC app
- myCadillac app
- Vehicle User Manual

GM ENERGY HOME PRODUCTS LIMITED WARRANTY

GM Energy provides a Limited Warranty for GM Energy Home Products, which are subject to certain terms, limitations and exclusions. Please visit <https://gmenergy.gm.com/for-home/here-to-help> for more information on the GM Energy Home Products Limited Warranty.

GLOSSARY

Frequently Used Terms and Acronyms

This glossary is a quick-reference guide to terms you may encounter in this guide, while talking to a provider or referencing other GM Energy resources.

Alternating Current (AC) – An electric current that alternates direction at regular intervals. Homes run on AC power

Amp (A) – Short for ampere, a unit used to measure electric current (i.e., how fast an electric current flows). Usually used in the context of EV charging (e.g., a 50-amp EV charger)

Automatic Backup Power – A setting found on your Compatible GM EV’s mobile app (myChevrolet, myBuick, myGMC or myCadillac); it must be enabled (switched on) in order for a GM EV to discharge power to a home using the GM Energy V2H Bundle

Battery electric vehicle (BEV) – A vehicle powered purely by a high-voltage battery. There is no gasoline engine and, therefore, zero tailpipe emissions

BDI – Abbreviation for bidirectional inverter, referred to here as the GM Energy Inverter. This is a component in the GM Energy V2H Bundle that makes Vehicle-to-Home (V2H) charging possible

Bidirectional – Refers to the ability of an inverter to direct power two ways – that is, from the power grid to the Compatible General Motors Electric Vehicle (EV) or from the GM EV to the home (V2H). This only works on Compatible GM EVs equipped with bidirectional technology

Charging – Replenishing an EV battery with electricity from an external source

Charging Coupler – The device attached to the cord that connects the GM Energy PowerShift Charger to a GM EV. Might also be referred to as a charging outlet or charging plug. It functions much like the hose and nozzle on a conventional fuel pump (In technical documents, this may be referred to as a CCS, which indicates it is a standard Combined Charging System)

Charging Holster – The wall-mounted unit that holds the Charging Coupler when it is not in use, included with the GM Energy PowerShift Charger

Charging Session Duration – Generally refers to the amount of time it takes for an EV to be fully charged, starting from the moment it is plugged into an EV charging station until the charging process is completed

Compatible GM EV – A GM electric vehicle that is equipped with discharging capability. For compatibility details, refer to the [GM Energy website](#)

Combined Charging System (CCS) – This configuration on the Charging Coupler enables DC fast charging capability

Commissioning – The step in the install process that turns the system on, updates system settings and connects the system to your wireless network. Final approval to operate may be dependent on inspections by local jurisdiction representatives

Direct Current (DC) – An electric current flowing in a single direction. EV batteries store energy as DC power

Electric Vehicle Supply Equipment (EVSE) – Any equipment, such as a wall-mounted charger or a portable cord set, used to charge an EV. The GM Energy PowerShift Charger is an EVSE

GM EV – A General Motors electric vehicle

GM Energy – An ecosystem of energy management products and services for home, commercial and GM EV customers offering a network of charging stations, dedicated back-up home power and a suite of new products to help create a more resilient grid

GM Energy Dark Start Battery – The unit responsible for providing low-voltage power to the GM Energy V2H system during grid outages, designed to “wake up” the system if a power outage lasts more than 10 minutes and the Compatible GM EV is not plugged in

GM Energy Home Hub – The Microgrid Interconnect Device that acts like your home’s electrical panel and circuit breakers to manage and distribute electricity from your GM EV to predetermined points in your home when there is a power outage

GM Energy Inverter – The unit that converts direct current (DC) to alternating current (AC) and controls how much power is being drawn from the vehicle and sent to the home. It is designed to intelligently manage multiple sources of off-grid power, such as from a power bank or solar panels. In some technical documents, it may be referred to as a BDI (Bidirectional Inverter)

GM Energy PowerShift Charger – The wall-mounted unit that delivers bidirectional charging to your Compatible GM EV and, in the event of a power outage, to your properly equipped home. It is part of the GM Energy V2H Bundle. In technical documents, it might be referred to as the Electric Vehicle Supply Equipment (EVSE)

ISC – Short Circuit Current

Kilowatt (kW) – A measurement of power (1 kW = 1,000 watts)

Kilowatt-hour (kWh) – A measurement of energy – how much power (kilowatts) can be supplied over a period of time (hours). This stored energy can be used/consumed at different rates. For example, 50 kWh stored in a battery could deliver:

- 2 hours of 25-kW power
- 5 hours of 10-kW power
- 50 hours of 1-kW power

GLOSSARY

Frequently Used Terms and Acronyms Continued

Level 1 charging – The type of charging usually done at home because it uses a typical 120-volt electrical outlet, charging between 8 amps and 20 amps. Level 1 charging is typically done with a portable charging cord

Level 2 charging – Often needs to be professionally installed and can deliver faster charging times than Level 1 chargers, charging up to 80 amps. Your GM Energy V2H Bundle provides Level 2 charging

Managed charging – Active control of how/when electricity for an EV is replenished via a power source that must also meet other power needs (i.e., demand response)

MID (Microgrid Interconnect Device) – The technical term for the GM Energy Home Hub device that's part of the GM Energy V2H Bundle

NEC – Abbreviation for the National Electrical Code. This refers to the United States standard for the safe installation of electrical wiring and equipment

OTA – Abbreviation for “Over-the-Air” software installation, the wireless technology that allows a system to automatically download software updates

PE – Abbreviation for “protective earth,” it refers to the protective grounding wire used in electric systems and cables. It may also be referred to as a protective grounding device, soil, grounding or simply as the ground wire

Range – The total distance an EV can travel on one full charge before the battery needs to be recharged

Rapid Shutdown Device (RSD) – To protect fire fighters and other first responders, an RSD quickly de-energizes (shuts off voltage in) auxiliary power systems, such as solar panels. Your installer will advise you regarding your system's needs

Vehicle Battery Reserve Level – The discharge threshold on your Compatible GM EV's battery that's required to maintain a minimum charge. When this is reached, the system will stop sending power to your home. Battery reserve level can be monitored using your GM EV's mobile app (myChevrolet, myBuick, myGMC or myCadillac)

Vehicle Grid Integration (VGI) – The passive and active management of electricity to and from Compatible GM EVs

Vehicle-to-Grid (V2G) – Allows the flow of electricity to and from the vehicle battery to support the electrical grid

Vehicle-to-Home (V2H) – Allows the flow of electricity from the vehicle battery to the home while disconnected from the grid during a power outage

Volt (V) – A measure of the electromotive force that drives electrons through a circuit. Homes in the U.S. run on 120 volts (regular outlets) and 240 volts (higher-powered outlets)

Watt (W) – The basic measurement of power (1 kW = 1,000 watts)